

Fig. 1

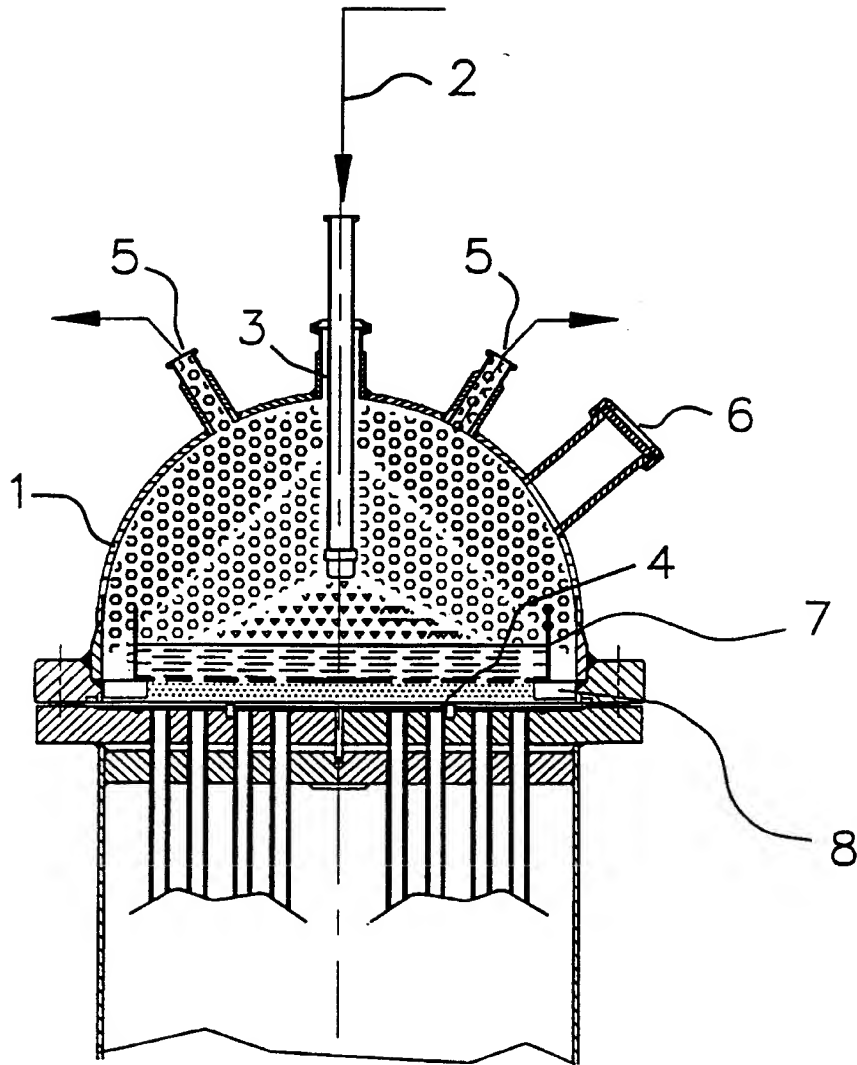

Fig.2

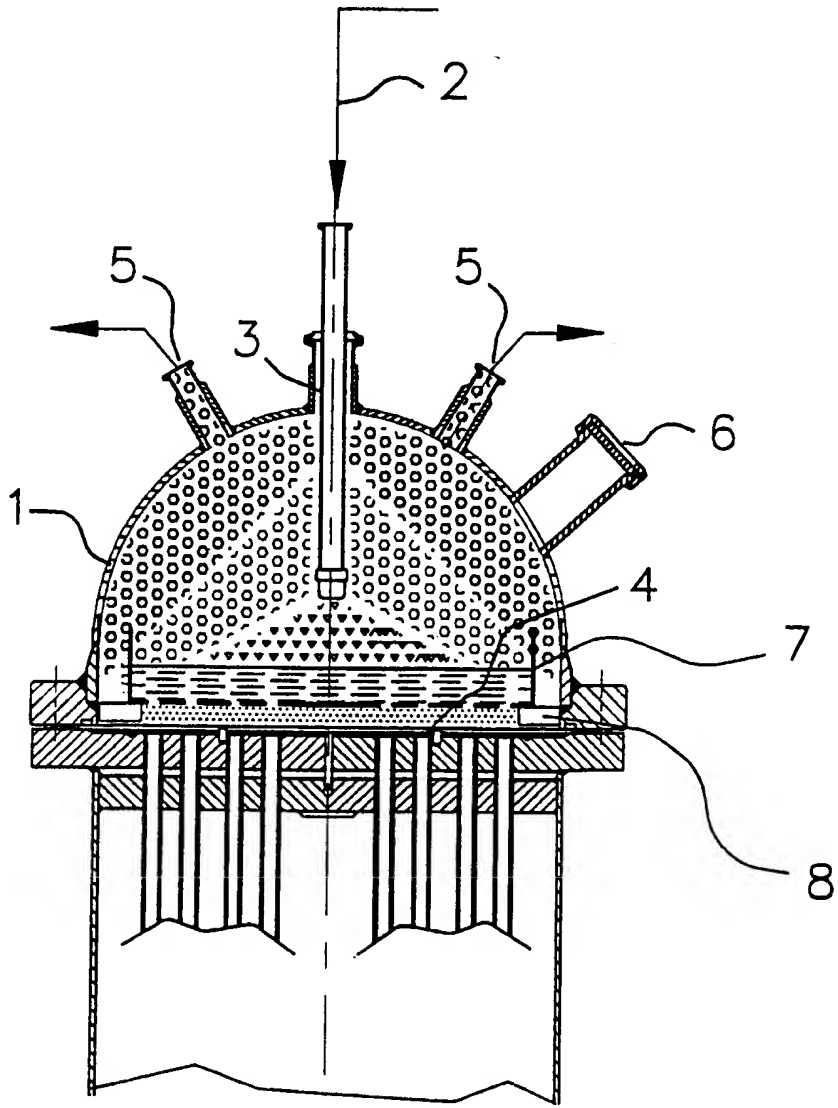

Fig.2